

SEELEVEL II™

HOLDING TANK MONITORS

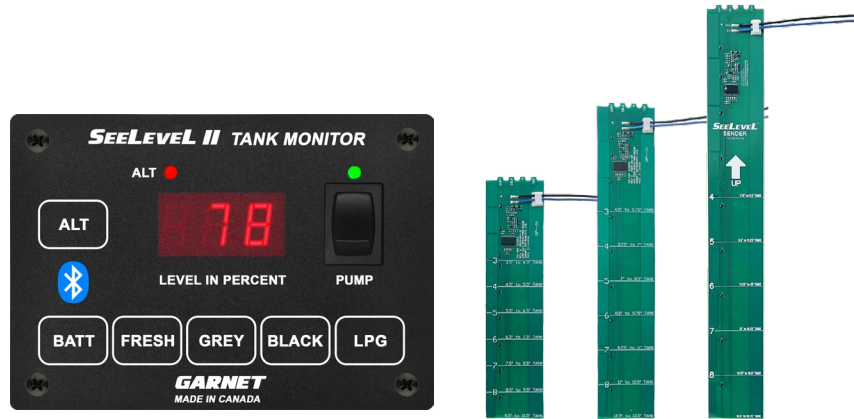

INSTALLATION GUIDE & USER MANUAL FOR 709-BTP7

SENDERS

710-AR2 | 710-ES3 | 710-SS2

INTRODUCTION

Through decades of experience and development the SeeLevel II™ tank monitor series has established itself as the gold standard in level measurement technology for the recreational vehicle industry.

The SeeLevel II™ 709-BTP7 builds on previous experience to offer an exceptional combination of features, accuracy, and reliability, ensuring an excellent user experience. It provides monitoring of up to 7 tanks, including 2 FRESH, 2 BLACK, and 3 GREY water tank levels. With Bluetooth capability and the latest SeeLevel RV 2.0 app, you can view real-time percentage readouts and receive alerts when tank levels are too high or too low. The 709-BTP7 monitors battery voltage and includes a pump switch for added convenience. In addition, the system can display the operating characteristics of each of the tank sending units, giving it unsurpassed diagnostic capability.

Printed in Canada

CANADA
Garnet Instruments Ltd.
286 Kaska Road
Sherwood Park, AB T8A 4G7

USA
Garnet US Inc.
5360 Old Granbury Road
Granbury, TX 76049

GARNET

Liquid management solutions, your way.

RVgauge.com | 1-800-617-7384

709-BTP7 Display and Sender Manual_v2.2 - 27-Mar-2026

TABLE OF CONTENTS

Select from contents list below to go to that page.

SAFETY INFORMATION	2
ABOUT THE SYSTEM	3
Model and Serial Number Info.....	4
INSTALLATION INFORMATION	4
Installation Documentation Downloads.....	4
Tools and Equipment to Install Display.....	4
SENDER INSTALLATION	5
Determine Best Placement & Configuration.....	5
Determine Measurable Space on Tanks.....	6
Sender Specifications.....	7
Cutting Senders.....	8
Programming the Senders.....	8
Prepare Sender for Installation.....	10
Wiring the Senders.....	11
Sender Test.....	12
Mounting the Senders.....	13
DISPLAY INSTALLATION.....	14
Display Panel Mounting Template.....	14
Connect Wiring to the Display.....	14
OPERATION GUIDE.....	15
To Read a Tank Level.....	15
To Read the Battery Voltage.....	15
To Read the LPG Tank Level.....	16
CONFIGURATION GUIDE	16
Set the LED Brightness.....	16
Program the Number of Senders (Enable/Disable tanks)	17
Calibrate the LPG Sender.....	17
Program Alarm Set Points for Each Tank.....	18
Enable/Disable the LPG Sender.....	19
Swapping a 4-Tank Display with a 709-BTP7 Display.....	19
TROUBLESHOOTING GUIDE.....	20
Error Codes.....	20
Sender Diagnostics	20
Wiring Diagnostics	21
Troubleshooting & Installation Tips	23
WARRANTY & SERVICE INFORMATION.....	25
APPENDIX A.....	25
Bluetooth Information	25

SAFETY INFORMATION

Read these instructions carefully and look at the equipment to become familiar with the device before trying to install, operate, service, or maintain it. The following special messages may appear throughout this manual or on the equipment to warn of potential hazards or to call attention to information that clarifies or simplifies a procedure. "Notes", "Cautions", and "Warnings" have been used to bring special matters to the immediate attention of the reader.

Safety Symbols

 **NOTE:** expands on information for any procedures.

 **CAUTION:** explains safety information that could cause damage to the product, including data loss.

 **WARNING:** explains dangers that might result in personal injury or death.

Changes or modifications not expressly approved by the party responsible for compliance could void the user's authority to operate the equipment.

Pump and Heater Switch Safety Precaution

 **WARNING:** All power circuits must be fused. If a fuse is not provided with the system then it is the installer's responsibility to install a fuse with the maximum rating your model requires. **A relay may be required for models with a pump or heater switch. For information about the requirements for your model please refer to the Specifications document located on our website.**

For more detailed information please refer to the chapter entitled TROUBLESHOOTING GUIDE", section "How to avoid damaging the display or pump switch due to excessive current".

2026 Garnet Instruments. All rights reserved. No part of this publication may be reproduced, Transmitted, transcribed, stored in a retrieval system or translated into any language in any form by any means without the prior written consent of Garnet Instruments. Information in this manual is subject to change without notice and does not represent a commitment on the part of GARNET.

The Senders

Each sender panel is a flexible self-adhesive printed circuit board which is adhered to the side of the holding tank. The sender panel can be cut to length to match the height of the tank, and auto calibrates so that it can read from Empty to Full regardless of the height of the tank.

In addition to the level, the sender also transmits diagnostic information about its operation. This information can be used to determine if there is buildup of sludge on the inside of the tank, or to determine if the sender is damaged or delaminating from the side of the tank. If sludge buildup in the tank becomes extreme the gauge will cease to operate properly, by monitoring the signal power the tank can be cleaned before the buildup gets excessive.

Multiple senders are available with the ability to double stack the senders to provide accurate level measurement for tank heights ranging from 3.5" to 34". **(See Sender Installation guide for available sender options-link on page 4)**

The Display

The display receives the information from sender panels via a single 2 conductor wire and shows the level information in percent of full on a 3-digit LED display, from 0% to 100%. When the button for a particular tank is pressed, the display shows the level for that tank.

Battery Voltage

The system also shows the RV battery voltage by measuring the voltage which powers the display. The voltage is shown with a resolution of 0.1 volt.

LPG

The display can measure the level of one LPG tank by connecting to the resistive based measuring points that are built into some LPG tanks. The Soul comes from the factory set to assume that 0Ω is empty and 100Ω is full, but can be re-calibrated to other resistance ranges.

Diagnostics

If a sender is operating properly and connected to the display with good wiring, then the display will show the level normally. If the wiring is disconnected, shorted, cut, or if the sender panel is defective, then the display will indicate an error code. The various error codes are shown in the section entitled "TROUBLESHOOTING GUIDE".

With these diagnostic features and the digital nature of the tank level sensing technology, it is almost impossible for the system to indicate an incorrect level. In the very unlikely event there is an error, servicing is greatly aided with the diagnostic information.

Bluetooth®

The display has *Bluetooth*® wireless technology, which allows you to check your tank levels, battery voltage, and LPG tank levels on any compatible smartphone or tablet device with a free downloadable app available on Google Play and iOS app stores.

(See separate manual for app installation and operation-link on page 4)

Alarm Output

The single common alarm output can be programmed to indicate a high or low sewage level, a high or low water level, or a high or low LPG level. More than one alarm can be assigned to the alarm output. This output can be connected to an indicator light and used to show a high sewer level and/or a low water level, alerting the user that attention is required. It could also be used to prevent toilet use if the black tank is full

Model and Serial Number Info

Before installing your system, look for the model and serial number on the back of the display, as shown below. Write these numbers below for future reference.

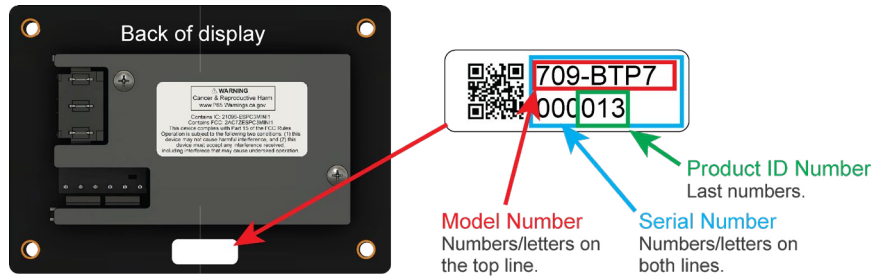

Document the following information for future reference.

Model Number: _____

Serial Number: _____

Date of purchase: _____

INSTALLATION INFORMATION

The installation for the complete system consists of mounting the display inside the RV, cutting, and mounting the senders to the sides of the tanks, connecting the wiring, and programming the display.

This manual provides information for the 709-BTP7 display which differs from other models due to the additional ALT button and red LED light. This button is needed for viewing and configuring secondary tanks. It is important to follow operation and configuration procedures for this model.

Installation Documentation Downloads

Other documentation will be required to complete installation for your specific model. Get them from our website Resource Library either by selecting the link below or scan the QR code and search for your model.

garnetinstruments.com/holding-tanks-resource-library/

- Wiring diagram for this model
- 709-BTP7 Bluetooth App
- Specifications



Tools and Equipment to Install Display

- screwdriver or power driver
- wire cutters/stripper
- wire crimper
- electrical tape
- butt connectors
- saw to cut a hole for display (if required)
- Optional items available to purchase if required. Go to our website for more information:

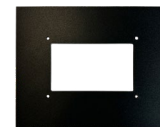

Filler Panel – to fit previous display hole that is too large.



Gasket – to prevent the display monitor from shorting if mounting to a metal surface.

SENDER INSTALLATION

Garnet offers three different sender options. They work on most plastic or polyethylene holding tanks that contain water-soluble fluids and are not compatible with metal holding tanks.

The 710-AR2 is 9" high. The higher resolution is 0.25" which is optimal for low-profile tanks. This sender is ideal for tanks 3.5"-11" tall but can be stacked with an additional 710-AR2 to measure tanks as tall as 11".

The 710-ES3 sender is 12" high. It has a resolution of 0.33" and is the most popular option, designed to measure liquid levels in most standard holding tanks. It is ideal for tanks 4.5"-14" tall but can be stacked with an additional 710-ES3 to measure tanks as tall as 26".

The 710-SS2 sender is 16" high. It has a resolution of 0.44" designed for taller tanks. It is ideal for tanks 7.5"-18" tall but can be stacked with an additional 710-SS2 to measure tanks as tall as 34".

See more information about sender lengths on page 7.

The communication protocol used between our senders and displays is proprietary allowing us to control the accuracy and functionality of our systems ensuring our customers experience reliable operation.

Before senders are installed the display should be installed first.

Refer to the **Display Installation Guide and User Manual** for the model you've purchased for all installation and connection details. All documentation can be found from the **Resource Library** found on our support page: <https://www.garnetstruments.com/support/>

Before installing
senders watch
this video!



SCAN TO WATCH

DETERMINE BEST PLACEMENT & CONFIGURATION

Sender Placement

The senders will need to have a flat area on the side of the tank large enough so the whole width of the sender is in contact with the side of the tank.

Make sure that any metal is at least 1" away from either side, top and bottom of the sender, and at least 2" away from the face of the sender.

Some tanks may have irregular shapes. DO NOT wrap the corners over the top or bottom of the tank.

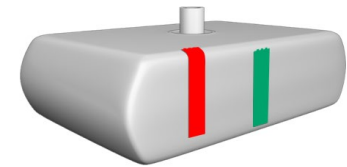

INCORRECT
CORRECT

See placement examples to the right.

CAUTION: Bending the sender sharply will damage the circuit on the sender.



INCORRECT
CORRECT

Sender Configuration

To determine which sender configuration you need, measure the height of your tanks, then find out the measurable space (*see following page*). The measurable space is the "ideal" position of the sender on the tank. This will determine what length the senders should be. If a sender is too long, it will need to be cut. The following table has recommended senders and configurations for various tank heights.

Recommended Sender Options

Tank Height	Best Sender Option
3.5" - 11"	710-AR2 single
11" - 14"	710-ES3 single
14" - 18"	710-SS2 single
18" - 20"	710-AR2, stacked
18" - 26"	710-ES3, stacked
26" - 34"	710-SS2, stacked

CAUTION: DO NOT mix sender types when stacking senders.

DETERMINE MEASURABLE SPACE ON TANKS

Find Measurable Space

Measure the height of the tank from top to bottom then determine measurable space.

- The minimum gap is 1/4", however, we recommend that the senders be installed 1/2" from the top and 1/2" from the bottom of the tank. Depending on the characteristics of the tank the gap can be a little more or less (see note below and installation tips on page 11). This gap ensures that the sender can read properly through the tank wall as the corners or rounded edges of the tanks can be too thick for the sender to read through.
- Subtract the gap space from the overall tank height. This will result in your measurable space. Use the calculation formula at the right.

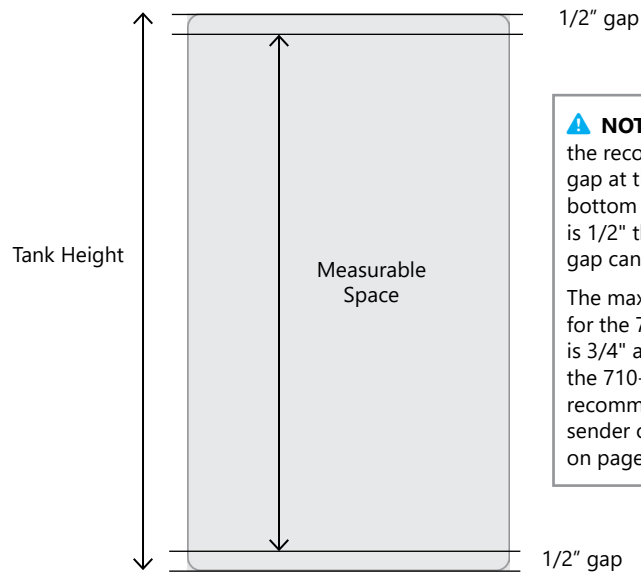

NOTE: Although the recommended gap at the top and bottom of the tank is 1/2" the minimum gap can be 1/4".

The maximum gap for the 710-AR2 is 3/4" and 1" for the 710-ES3. See recommended sender options table on page 2.

CAUTION: Installing a sender outside of the recommended measurable space may affect your readings.

NOTE: This is not a static formula that can be used on every tank. With some fresh tanks, the outlet for the pump feed may sit more than 1 inch above the bottom of the tank. Your water pump may begin to suck air before the tank is completely empty. In these cases, you want to install the fresh tank sender above the outlet for the pump feed. This will ensure that the monitor reads "0" before the pump begins to suck air.

Single configuration

- Measure the height of the tank.
- Tank height = _____
- Calculate the recommended measurable space as follows:

$$\text{Tank height} - \text{top gap} - \text{bottom gap} = \text{measurable space.}$$
**See note regarding gap recommendations.*

NOTE: If senders do not fit full height of the tank, to optimize the level you can justify sender location to be either closer to the top or bottom, depending on the type of liquid (Fresh or Grey/Black).

FRESH = closer to bottom as it is preferable that this tank is not empty!

GREY/BLACK = closer to top as it is preferable that these tanks are not full!

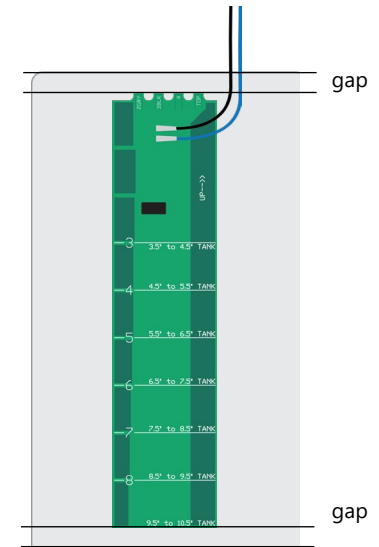

Stacked configuration

Two senders may be required for taller tanks and additional senders may be purchased for this application. There needs to be a gap of 1/16" to 1/8" between the double stacked senders. Calculate what the total length of measurable space for both senders will be:

- Measure the height of the tank.
- Tank height = _____
- Calculate the recommended measurable space
- $$\text{Tank height} - \text{top gap} - \text{bottom gap} - \text{middle gap} = \text{measurable space.}$$
**See note regarding gap recommendations.*

NOTE: Both senders in a double-stacked configuration should be approximately the same length.

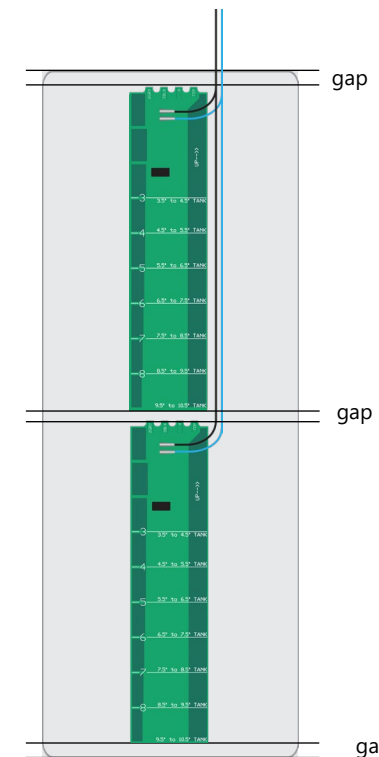

SENDER SPECIFICATIONS

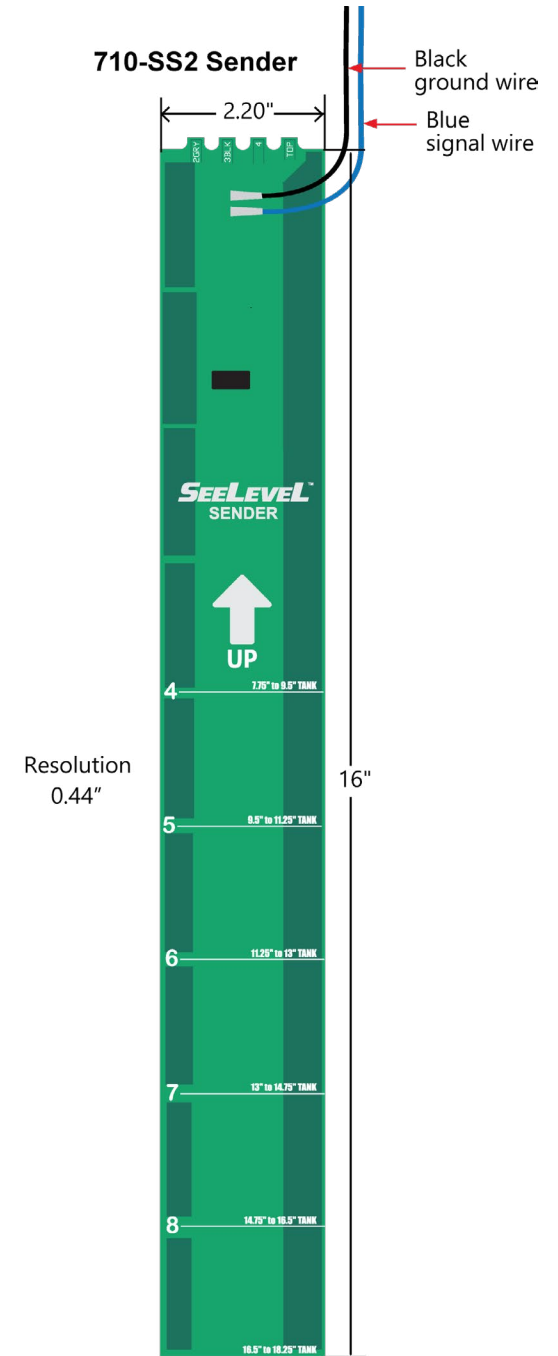
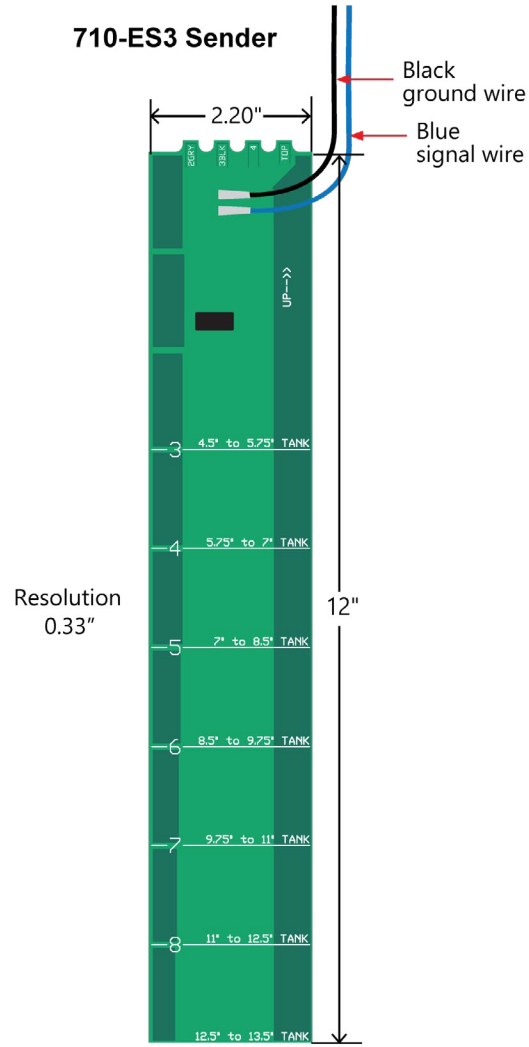
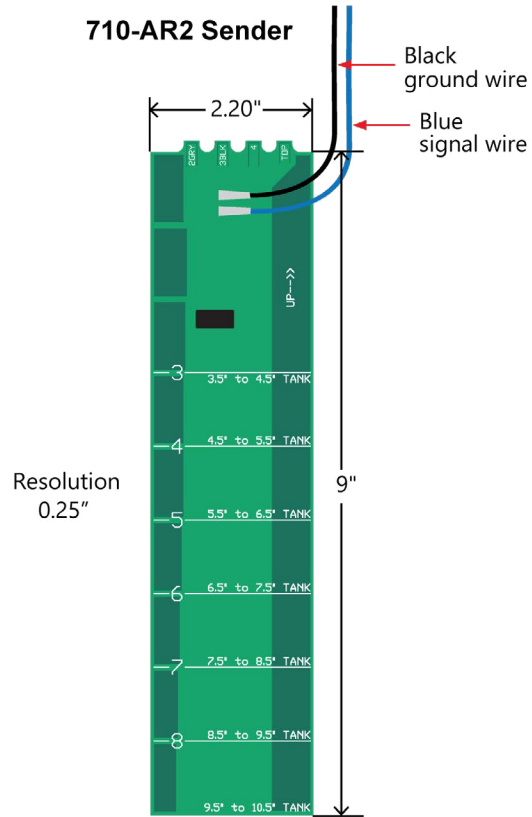

CUTTING SENDERS

The senders need to be cut to the required length to match the height of the measurable space of the tank.

The cut must be between the sender segmented pads. Senders have a minimum length they can be cut. The minimum length is after the first three segmented pads.

Once this has been determined, cut the sender with a pair of scissors.

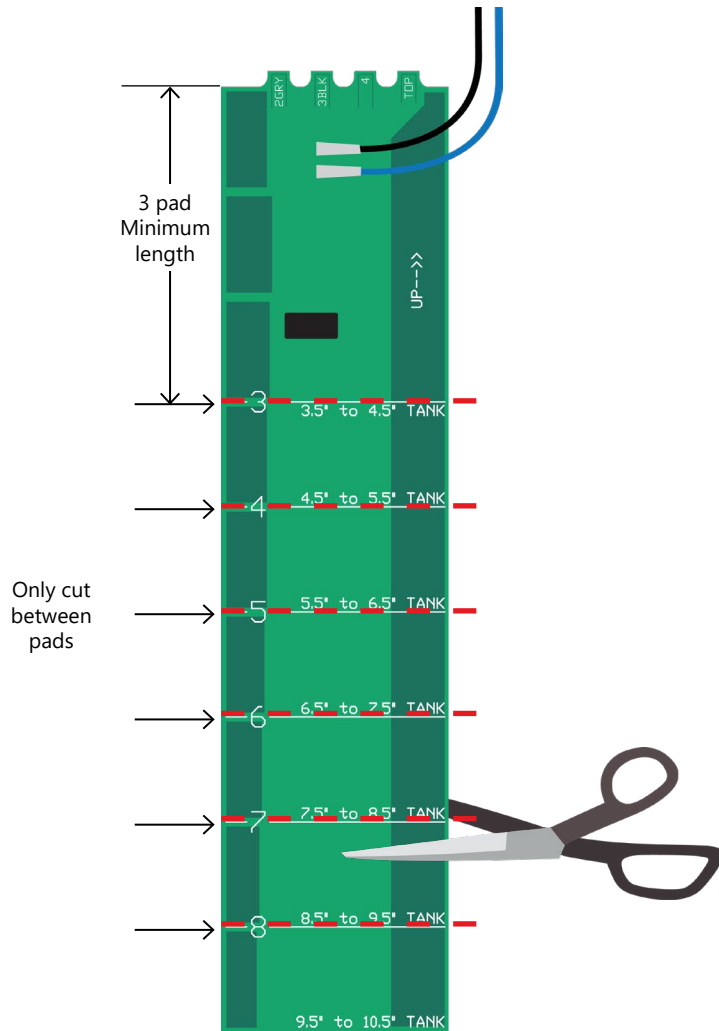

PROGRAMMING THE SENDERS

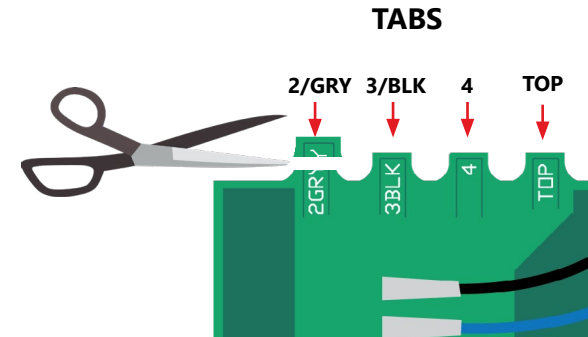

Senders are programmed by cutting off the tabs at the top of each sender to tell it which tank it will be mounted on, or if in a stacked configuration, whether they are on the top or bottom. A pair of scissors or a hole punch can be used to cut the sender tabs.

For tanks 5 through 7, use the sum of two tab numbers for that tank number. This will only work on display models that can read up to 7 tanks.

For examples of programming for each tank types refer to the table at the bottom and the illustrations on the next page.

TANK TYPE	TABS TO CUT
FRESH	No tab cut
GREY	2GRY
BLACK	3BLK
FRESH 2 (TANK 4)	4 (For 709-BTP7 & Soul only)
GREY 2 (TANK 5)	2GRY + 3BLK (For 709-BTP7 & Soul only)
BLACK 2 (TANK 6)	2GRY + 4 (For 709-BTP7 & Soul only)
GREY 3 (TANK 7)	3BLK + 4 (For 709-BTP7 & Soul only)
GALLEY (only for displays with a GALLEY button)	2GRY + TOP (For 709-4P, 709-4LP 709-4PH only)
TOP Sender	Cut "TOP" tab + tank type tab

⚠ CAUTION: MAKE SURE YOU CUT THE CORRECT TABS! Cutting the wrong tabs will result in incorrect programming and this cannot be reversed and is not covered under warranty

Tabs to cut for single sender or bottom sender if double-stacked.

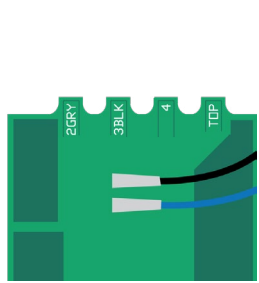

FRESH

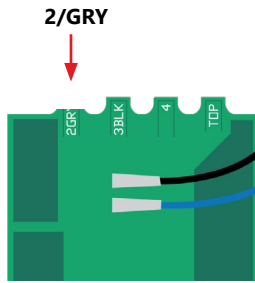

GREY

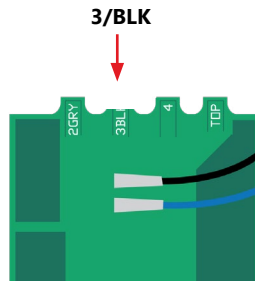

BLACK

NOTE: Previous model senders (710-JS, 710-ES, 710-ES2, 710-SS) can be combined with new sender models.

NOTE: For systems that have a Galley button. Cut the 2/GRY and the TOP tabs. For displays that have a GALLEY button the GREY and GALLEY tanks can only have one sender per tank and cannot be stacked.

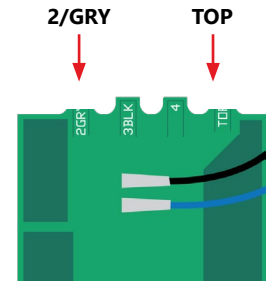

GALLEY

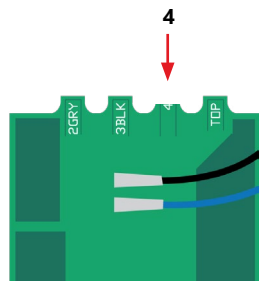

**FRESH 2
(TANK 4)**

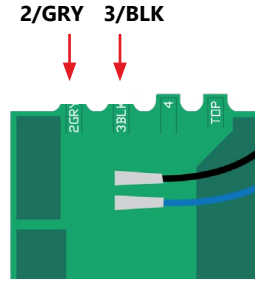

**GREY 2
(TANK 5)**

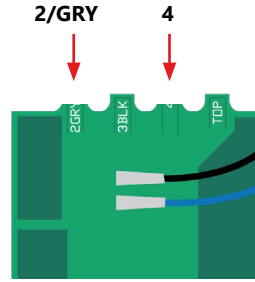

**BLACK 2
(TANK 6)**

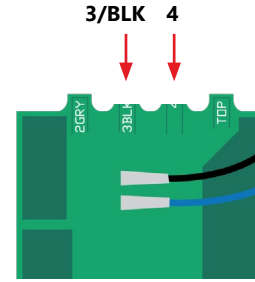

**GREY 3
(TANK 7)**

CAUTION: MAKE SURE YOU CUT THE CORRECT TABS! Cutting the wrong tabs will result in incorrect programming and this cannot be reversed and is not covered under warranty

NOTE: For tanks 5 through 7, use the sum of two tab numbers for that tank number. This will only work on models that can read up to 7 tanks.

For a double-stacked tank configuration, the top sender requires an additional tab to be cut.

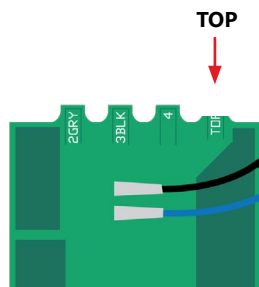

FRESH TOP

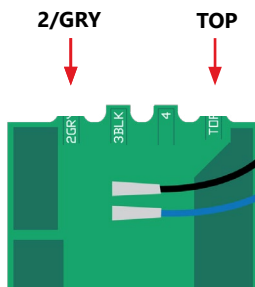

GREY TOP

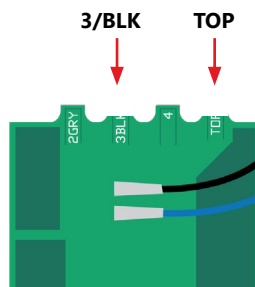

BLACK TOP

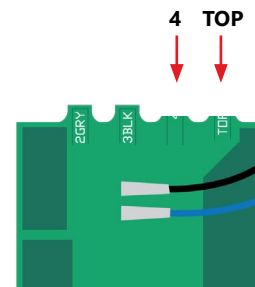

**FRESH 2 TOP
(TANK 4)**

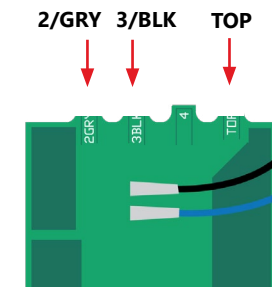

**GREY 2 TOP
(TANK 5)**

For Tanks 4 - 7 also cut the TOP tab as these examples indicate.

PREPARE SENDER FOR INSTALLATION

1 Clean the tank

Clean area thoroughly where the sender will be mounted making sure there is no dust, grease and oil.

Acetone or rubbing alcohol will remove sticky residue.



2 Temporarily tape sender on tank

CAUTION: DO NOT SKIP THE FOLLOWING STEPS. Removing the sender from the tank after the sender has been permanently installed will cause damage to the sender that is NOT covered under warranty.

Once the sender is cut and programmed, temporarily tape the sender to the tank wall. Place a piece along the length of both sides of the sender and perform a test to verify operation.

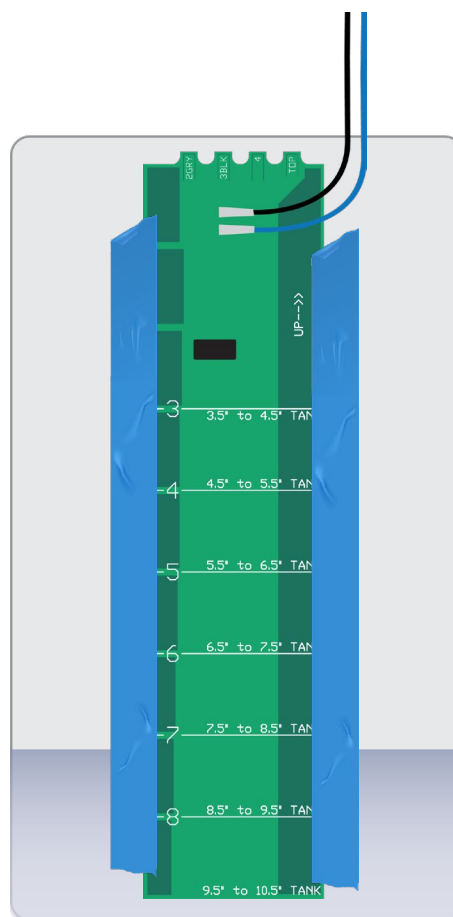

CAUTION: Route wires to the right, away from the senders. The wires indicate the top of the sender.



Use a non aggressive tape like painters tape or masking tape.

3 Connect the wiring to the pigtail

The following diagram shows the wiring from the sender to the pigtail. Other wiring connections may apply for each model. All wiring diagrams are available on the website.

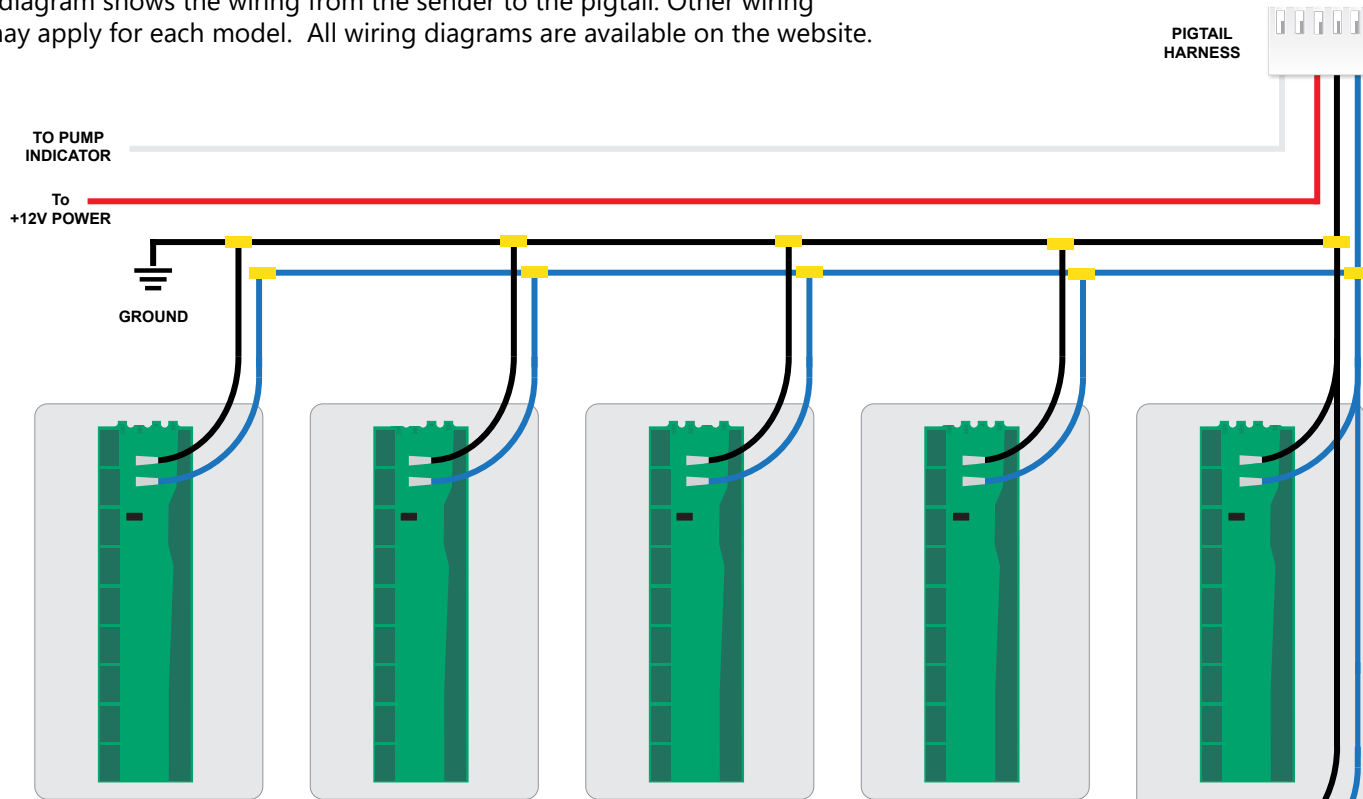

Up to 7 tanks can be connected.

CAUTION: Wires are to be routed to the RIGHT side of the sender, away from the sender. Never route the wires to the left of the sender. If they drape over the sender they could affect the reading.

CAUTION: It is very important that the display and senders have the same ground. Make sure the sender ground connection is connected back to the display ground or breaker panel ground.

Stacked configuration

4 Verify operation before permanently adhering the sender to the tank.

NOTE: The display needs to be installed and power supplied before the sender operation can be verified. Once verified, sender is ready to be permanently mounted.

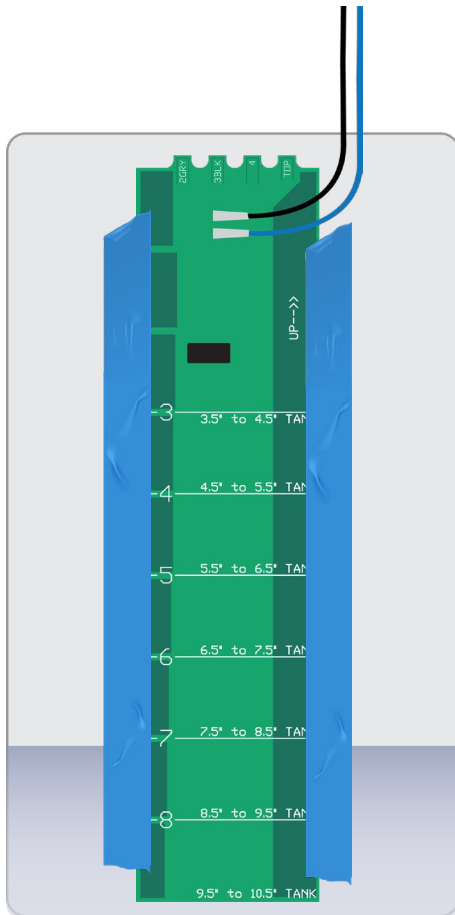

Tank levels operation test

For the initial test, have the tank at least 1/4 full of water or sewage.

Verify that the percent level reading on the display panel looks correct.

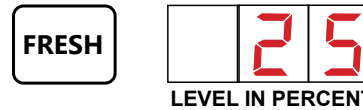

Signal strength test

The signal power is an indication of how much signal is being transmitted through the tank wall and picked up by the receiver part of the sender.

Typical signal power should be 50% to 60%. The gauge will work with minimum signal strength as low as 20%, but it is good to have at least 50% to 60% at installation so that there is some margin available for buildup in the tank. $P_{TDS} = 100\%$.

MOUNTING THE SENDERS

5 Permanently adhere sender to the tank

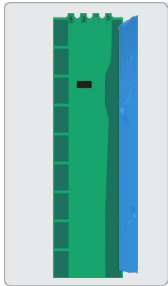

Once proper operation has been confirmed, the sender will be ready to be permanently installed to the tank wall.

Remove one side of the tape.

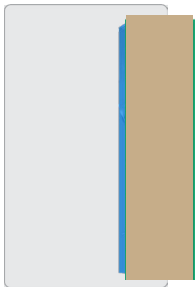

Fold the sender over so it is still attached with one side of the tape.

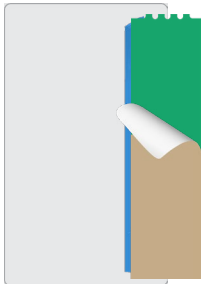

Slowly peel the backing paper off the adhesive.

⚠ CAUTION: Be careful not to bend the senders excessively or you could damage the circuits. You only have one shot at this. If you try to peel it off the tank once it is stuck the sender may be damaged by the sharp bending. Removing the sender after it's been adhered voids the warranty.

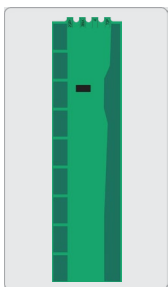

Carefully fold the sender back and press the sender down to the tank so that all of the adhesive is contacting the tank wall. Make sure there are no air gaps between the sender and the tank. Remove the other side of the temporary tape.

6 Secure the wires

Secure the wires with duct tape, tie wraps, or something similar so that the wires do not rattle or press against the sender, this may result in sender damage or wires breaking over time.

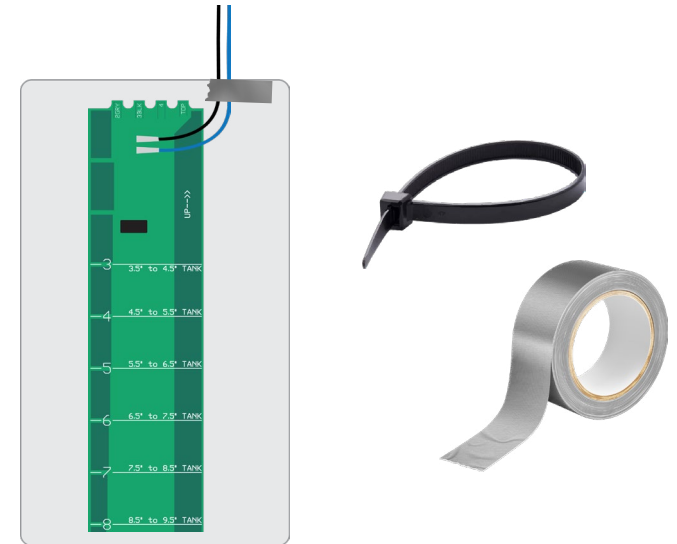

7 Apply undercoating to the senders

On installations where the holding tank is exposed to under chassis road spray and flying rocks etc. the installer must use added protection. We suggest:

Gorilla Glue Waterproof Patch & Seal Tape

3M 03584 Professional Grade Rubberized Undercoating

Gravel Guard Rocker Guard Coating By Dominion Sure Seal

DISPLAY INSTALLATION

The installation consists of mounting the display inside the RV, programming, cutting and fastening the senders to the sides of the holding tanks, connecting the wiring, and programming the display. When wiring DO NOT use spade connectors to join wires, only use crimp-on butt connectors or solder the wires together.

Display Panel Mounting Template

Mount the display by cutting a hole in the wall with the given dimensions plus four screw holes. The thickness of the RV wall needs to be thick enough to retain the screws. The panel will be mounted onto the wall using the four included #4 screws, or different screws as required. The cutout diagram below is actual size and can be used as a template. The depth of each model varies 1" - 1 3/8" (25 - 35 mm), model dependent.

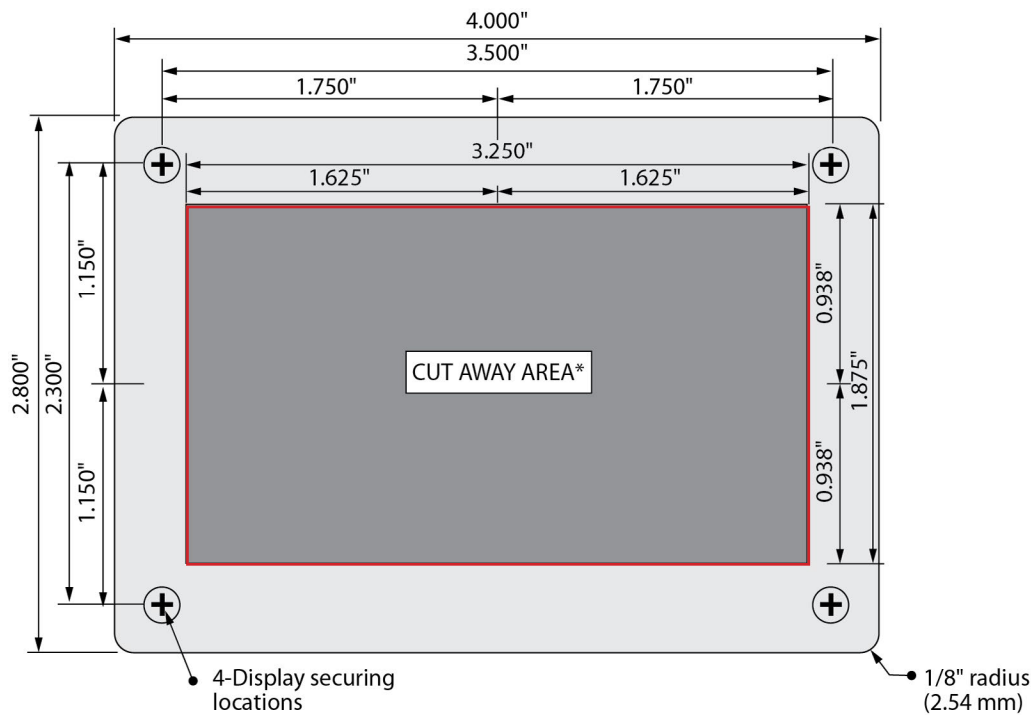

⚠ WARNING: The back of the display must not be accessible after installation.

⚠ CAUTION: If mounting the display in a metal panel or wall there is a risk the display can short circuit causing permanent damage. Non-conductive mounting spacers are available to purchase to help prevent damaging the display. Contact Garnet or go to our website for further details. More installation tips are available in the "Troubleshooting and Installation Tips" section.

Connect Wiring to the Display

It is easier to connect the wiring to the display connector first, and then plug the connector into the display panel. **Refer to the wiring diagram for your model from our Resource Library using the link or QR code on page 4.**

The senders need to be grounded to a single ground wire from the display. **Make sure that the system ground is connected to the breaker panel ground.**

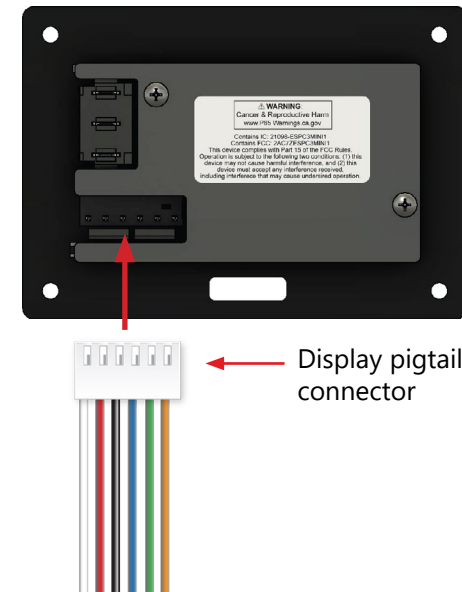

⚠ WARNING: All power circuits must be fused. If a fuse is not provided with the system then it is the installer's responsibility to install a fuse with the maximum rating your model requires.

A relay may be required for models with a pump or heater switch.

For information about the requirements for your model please refer to the specifications page and wiring diagram.

OPERATION GUIDE

The display is the only system component that is accessed by the user. All user input to the display is done using the buttons along the bottom of the display.



To Read a Tank Level

Press and release the corresponding tank button to display the tank level. LED display shows the level in percent.



Display shuts off after 5 seconds.



To read the secondary Fresh/Grey/Black tanks, press and release **ALT** then press the button for the corresponding tank. The LED display will show the level and the ALT light will be on.



To view the 3rd grey tank (galley), press and release **ALT**, and then press **LPG**.

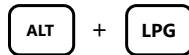

Additionally, the screen will briefly flash "Fr 1" or "Fr 2" before showing the level, to differentiate between the two fresh tank, or "Gr 1", "Gr 2", "Gr 3" for the three grey tanks, and "bL 1" or "bL 2" for the two black tanks.

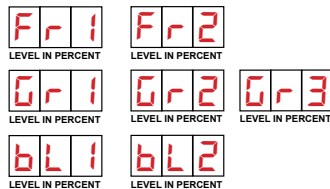

To continuously display a reading, press and release the desired button twice. For secondary tanks, **ALT** must be pressed and released first.

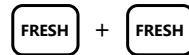

Continuous display mode is indicated by a decimal point on the right hand side. The level is updated once per second. User can watch the level change while the tank is being filled or drained.



Continuous display mode shuts off after 5 minutes. To end the hold mode sooner, press any tank button and display will shut off.

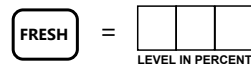

To Read the Battery Voltage

Press and release the **BATT** button to display the battery voltage. LED display shows the battery level in volts.



The display shuts off after 5 seconds.



To continuously display reading, press and release the **BATT** button twice.

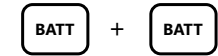

The reading may flicker back and forth between two values, for example, 12.6 and 12.7 volts. This is normal behavior for a digital voltage display.



To read a tank level or LPG level, the corresponding button can be pressed at any time. The 5 second timeout is restarted every time a button is pressed.



To disable or enable Always On Display (AOD):

Enter programming mode by pressing and holding **BATT** and **ALT**, after a few seconds, the display will briefly flash "SEt", indicating you are in the settings menu.

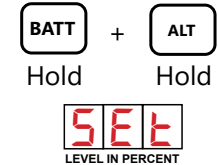

To scroll through options, press **BLACK** to move upwards and **FRESH** to move downwards until the display indicates 'Aod' for always-on display.



Press **ALT** and select between "On" and "OFF" using the **BLACK** and **FRESH** buttons, and make your selection.

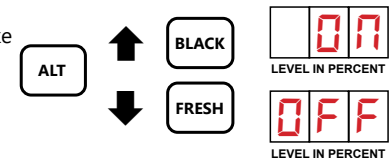

Press the **BATT** button to save and exit the programming mode.



If you choose "On" then the battery voltage is continuously displayed very dimly to save power until the setting is disabled.



To Read the LPG Tank Level

- Press and release the **LPG** button to display the LPG level in percent.



- The display shuts off after 5 seconds.



- Press and release the **LPG** again, to display a new reading. The 5 second timer will be restarted.



- To hold the **LPG** level on the screen, press, press **LPG** twice. Continuous display mode is indicated by a decimal point on the right hand side.



- The display will shut off 5 minutes after the button is released.



- To read another tank level or battery voltage, the corresponding button can be pressed at any time. The 5 second timeout is restarted every time a button is pressed.

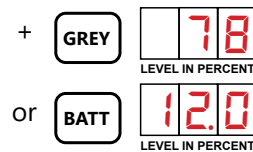

CONFIGURATION GUIDE

Set the LED Brightness

The LED brightness can be adjusted to suit the user and the operational circumstances. If it is to be used in the service bay area where sunlight can reach it, the LED brightness should be high.

- To program the LED brightness, enter the brightness programming mode. To do this, press and hold down **BATT** and **ALT**. After a few seconds the display will briefly flash "SEt" indicating you are in the settings menu.

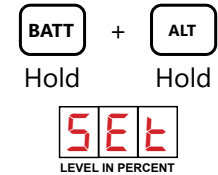

- Scroll through options, press **BLACK** to move upwards and **FRESH** to move downwards until the display indicates "br i" for brightness.



- Press **ALT** again, and using the **FRESH** and **BLACK** buttons, select a value between 0 and 9. The current brightness level is displayed. b-0 is the minimum brightness and b-9 is the maximum brightness.

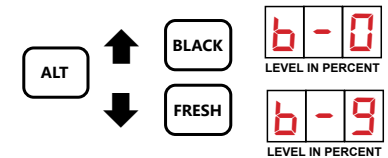

- Press the **BATT** button to save and exit the programming mode.



Program the Number of Senders (Enable/Disable tanks)

To program the number of senders for each tank, the display needs to enter the sender programming mode. By default each tank is set for single sender application. This should only be done at the time of installation; there is no reason to change the number of senders afterward. Make sure that the number of senders programmed into the display matches with the number of senders connected; otherwise the display will show an error.

- To configure the number of senders for a tank, hold down **BATT** and the button for the tank to be programmed.

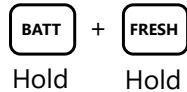

- After a few seconds, the screen will briefly display the name of the tank that you are entering tank setup for, (i.e. "Fr 1" for fresh 1), and then you are in the programming mode for that tank.



- Use **FRESH** and **BLACK** to scroll up and down through the menu until "SEn" for senders is displayed. Press **ALT** to select.



- Select the number of senders between 0 and 2 using the **FRESH** and **BLACK** buttons. Setting it to 0 disables that tank reading. "1SE" indicates a single sender. "2SE" indicates a stacked pair of senders. Press **BATT** to save the setting. The screen will briefly show "SE0" to indicate that the setting is being stored.

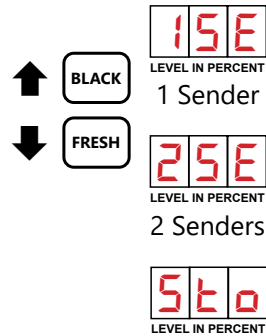

- To configure the number of senders for a secondary tank, instead of holding **BATT** and the corresponding tank button, press and hold **ALT** and the corresponding tank button.

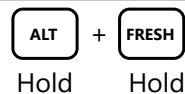

- To access the setting for the third Grey tank (galley), hold **ALT** and then hold **LPG**.

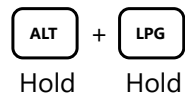

Calibrate the LPG Sender

The LPG tank must be full when the sender is calibrated, otherwise the calibration will be invalid. Fill the LPG tank by using an alternate measurement method, such as weight, a spit valve, or a mechanical gauge on the tank.

- To calibrate, hold both **BATT** and **LPG** buttons.

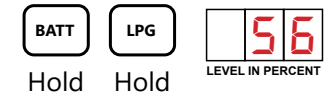

- It will display "LPG" briefly to let you know you are in LPG programming mode.

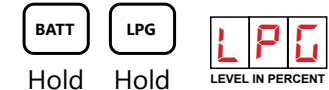

- Use **FRESH** and **BLACK** to scroll up and down through the menu until "CAL" for calibration is displayed.



- Press **ALT** to calibrate. It will flash "cLP" to let you know a calibration is in process, and then "06" to let you know it is done.

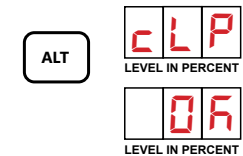

- Press the **BATT** button to save and exit the programming mode.



Program Alarm Set Points for Each Tank

To program the alarm point for each tank, the display needs to enter the alarm programming mode.

- To set an alarm for a tank, hold down **BATT** and the button for the tank to be programmed.

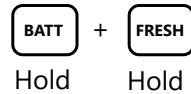

- After a few seconds, the screen will briefly display the name of the tank that you are entering tank setup for, (i.e. "Fr 1" for fresh 1), and then you are in the setup menu for that tank.



- Use **FRESH** and **BLACK** to scroll up and down through the menu until "ALr" for alarm is displayed. Hold **ALT** and **GREY** to enter the sub-menu.



- The LED will display a symbol representing above ("n") on the left, and a number on the right. This means the alarm will trigger above the programmed threshold



NOTE: The example on the right represents a warning alarm that will trigger above 90%.

CAUTION: If an external alarm module is configured, changing this setting will overwrite the configuration. Please contact the dealer for alarm module configuration.

- Press and hold **FRESH** to change between above or below setting. Above the threshold is represented by the "n" symbol, below the threshold is represented by the "u" symbol.



NOTE: The example on the right represents a warning alarms that will trigger above 90% for one tank and below 10% for another tank.

- Use **FRESH** and **BLACK** to increase or decrease the alarm level, shown in percent. Setting alarm threshold to 0 disables it. Press and hold **BATT** until the screen displays "5E0" to save and exit.

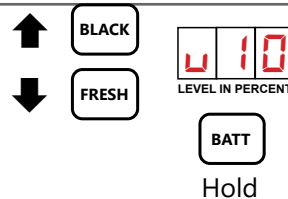

NOTE: The example on the right represents a warning alarm that will trigger below 10%.

- Press and hold **BLACK** to change between the shut down and warning alarm. The same above/below symbols are used, but the shut down alarm is represented by the symbol being in the top half of the digit, and warning symbol in the bottom half of the digit.

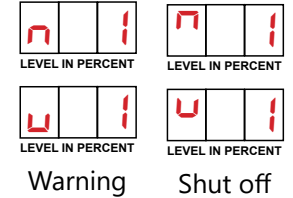

- Two alarm set points are possible for each tank, tied to the same output. Most cases will only need 1 alarm.
- An active alarm connects the orange wire to ground. It is suitable for small loads like LEDs or relay coils (max 750mA).

NOTE: All alarms are tied to the single common alarm output. Additional alarms are possible with the external alarm module.

Unless external alarm module is used the warn and shutdown will behave the same.

Enable/Disable the LPG Sender

- Hold both **BATT** and **LPG** buttons. Screen will flash "LPG" indicating you are in the LPG settings menu.

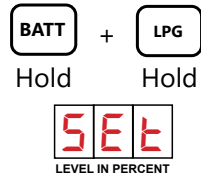

- Use the **BLACK** to move up and **FRESH** to move down until the display reads "En".

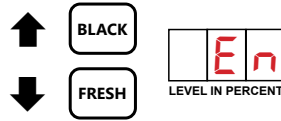

- Press **ALT** to enter the menu. Choose between "On" and "OFF" using the **FRESH** and **BLACK** buttons, and make your selection.



- Press the **BATT** button to save and exit the programming mode.



Swapping a 4-Tank Display with a 709-BTP7 Display

If you are swapping a 4-tank display (with a galley tank) for a 709-BTP7 display, you will have to follow these steps.

- The BTP7 wiring is compatible with the wiring of legacy 4 tank displays. The steps on page 5 of this manual should be followed.

- Power it up and enter the setup menu by holding **BATT** and **ALT** buttons for a few seconds (it's the same menu from page 7 of the manual). It will flash "SEt" and then it will show the first menu item with is "br i" for brightness.

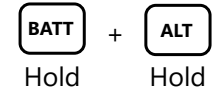

- Scroll up and down in the menu using the **FRESH** and **BLACK** buttons until you see "c4P" (it stands for compatibility 4P). Press **ALT** button to enter this menu.



- Use **FRESH** or **BLACK** buttons to change the selection to "On", and then press **BATT** button to save and exit.

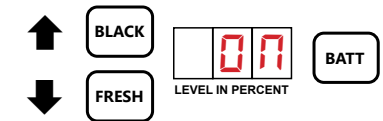

- The 709-BTP7 will now interpret your galley sender as the GREY 2 tank. (Refer "To Read a Tank Level" on page 16 for viewing GREY 2)











- Since the 709-BTP7 comes from the factory with only Fresh, Grey, and Black tanks enabled, you'll need to enable Grey 2 tank. (Refer to step 5 "Program the Number of Senders" on page 17 for instructions).

- If each of your tanks uses a single sender, no additional configuration is required. If you encounter any errors when viewing your tank levels, start by following the steps on page 17 to confirm that each tank is set to use 1 sender.

TROUBLESHOOTING GUIDE

Error Codes

If a sender or its wiring is not operating properly, the following codes are shown on the display:

DISPLAY CODE	POSSIBLE CAUSE	SOLUTION
Open circuit  LEVEL IN PERCENT	1. If a sender is unresponsive. 2. There is an open circuit in the wiring so the sender is not connected.	See Wiring Diagnostics flowchart on page 21 - 22.
Short circuit  LEVEL IN PERCENT	Blue communication wire from senders to display is shorted to ground.	
Error  LEVEL IN PERCENT	Indicates signal corruption between the sender and display due to bad wiring, bad senders, or multiple senders programmed the same.	Check all the senders to make sure they are programmed correctly. If they are, replace the sender that is creating the error.
Stacked senders  LEVEL IN PERCENT	The display has been programmed for a single sender where double-stacked senders have been connected. The display has not been set to look for two senders	Change the senders or reprogram the display as required.
No top sender  LEVEL IN PERCENT No bottom sender  LEVEL IN PERCENT	The display has been programmed for double-stacked senders and one of these error codes are showing: • ntP - only the bottom sender is reporting • nbo - only the top sender is reporting	Correct the programming on the sender.
Calibration failure  LEVEL IN PERCENT	The memory used to store programming for battery voltage calibration value and tank sender signal values has failed.	Replace the display.
For LPG only  LEVEL IN PERCENT	The only LPG diagnostic code is the open circuit. If the wiring to the LPG sender is shorted then the LPG will always show "0".	
Bit count error  LEVEL IN PERCENT	The sender is not communicating properly the BTP7 display.	This can happen if two senders are programmed to the same address by cutting the same tabs. This can also happen if there is excessive noise on the sender bus, or if the voltage to the 12V input is very low.

NOTE: There are no diagnostics for battery voltage.

Sender Diagnostics

These diagnostics can be used to check the senders:

Reviewing Sender Diagnostics

The sender diagnostics can be reviewed periodically to check for any degradation of the tank senders. If a sender appears to be malfunctioning, reviewing the diagnostics should be the first step in the troubleshooting process. There are two diagnostics for the senders:

Sender signal power is an indication of how much signal is being transmitted through the tank wall and picked up by the receive part of the sender. **Sender height** is the number of receive segments present in the sender.

SIGNAL POWER PROBLEM	POSSIBLE CAUSE	RESULT
If the signal power is too low.	It can indicate a sender which is detached from the tank, excessive buildup on the inside of the tank, bad wiring to the sender, low battery voltage, or a defective sender.	Typical signal power should be 50% to 60%. The minimum signal power for proper operation is 20%. P00 is 100%

SENDER HEIGHT PROBLEM	RESULT
The number of segments reporting is less than the amount of segments on the sender.	One or more segments are not reporting. Either cut sender to a shorter length or replace the sender.
The senders always auto calibrate to the length that they are cut, so this diagnostic allows the user to confirm the length and to make sure that the auto calibration is working properly.	

Wiring Diagnostics

OPEN CIRCUIT

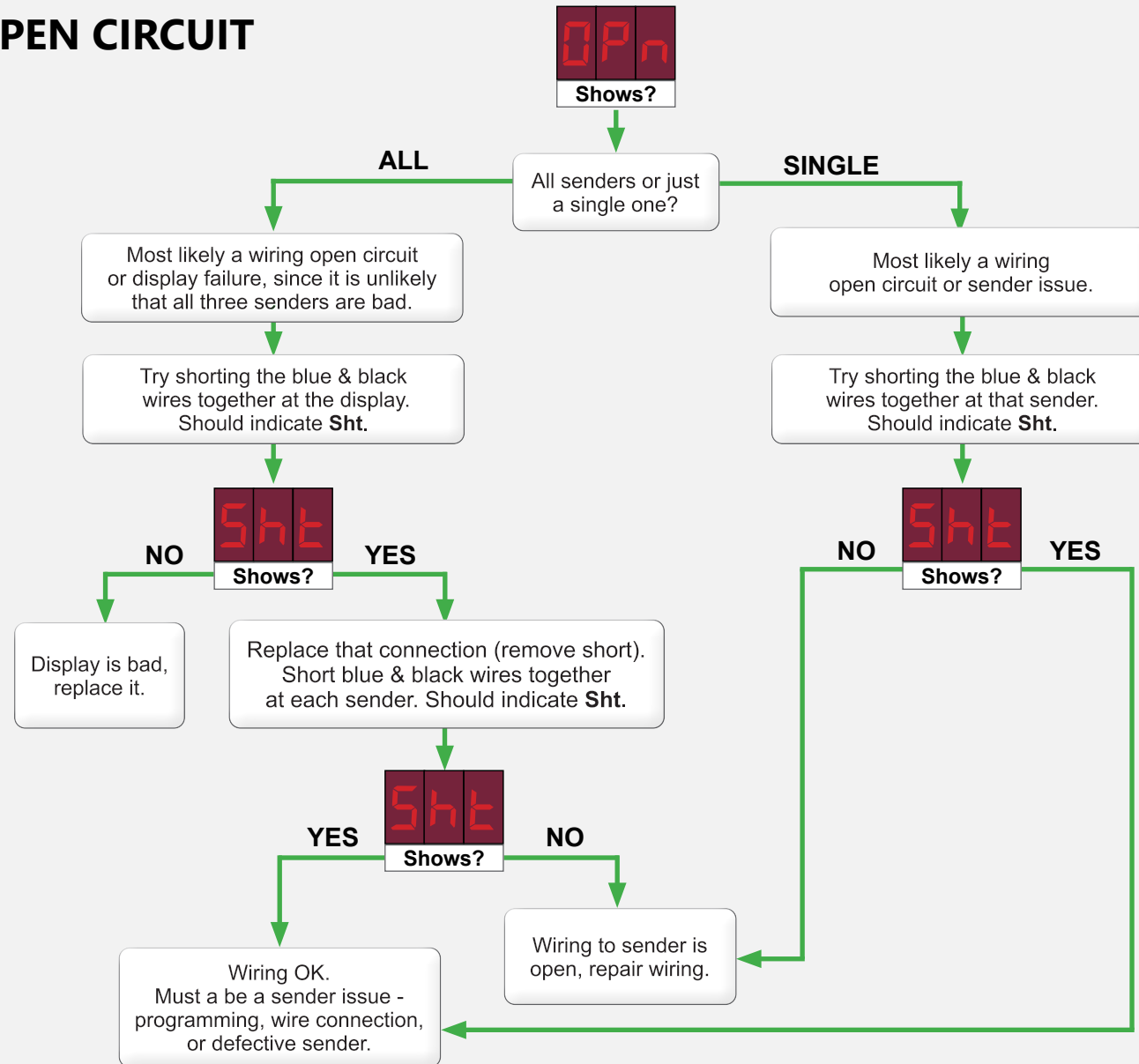

SHORT CIRCUIT

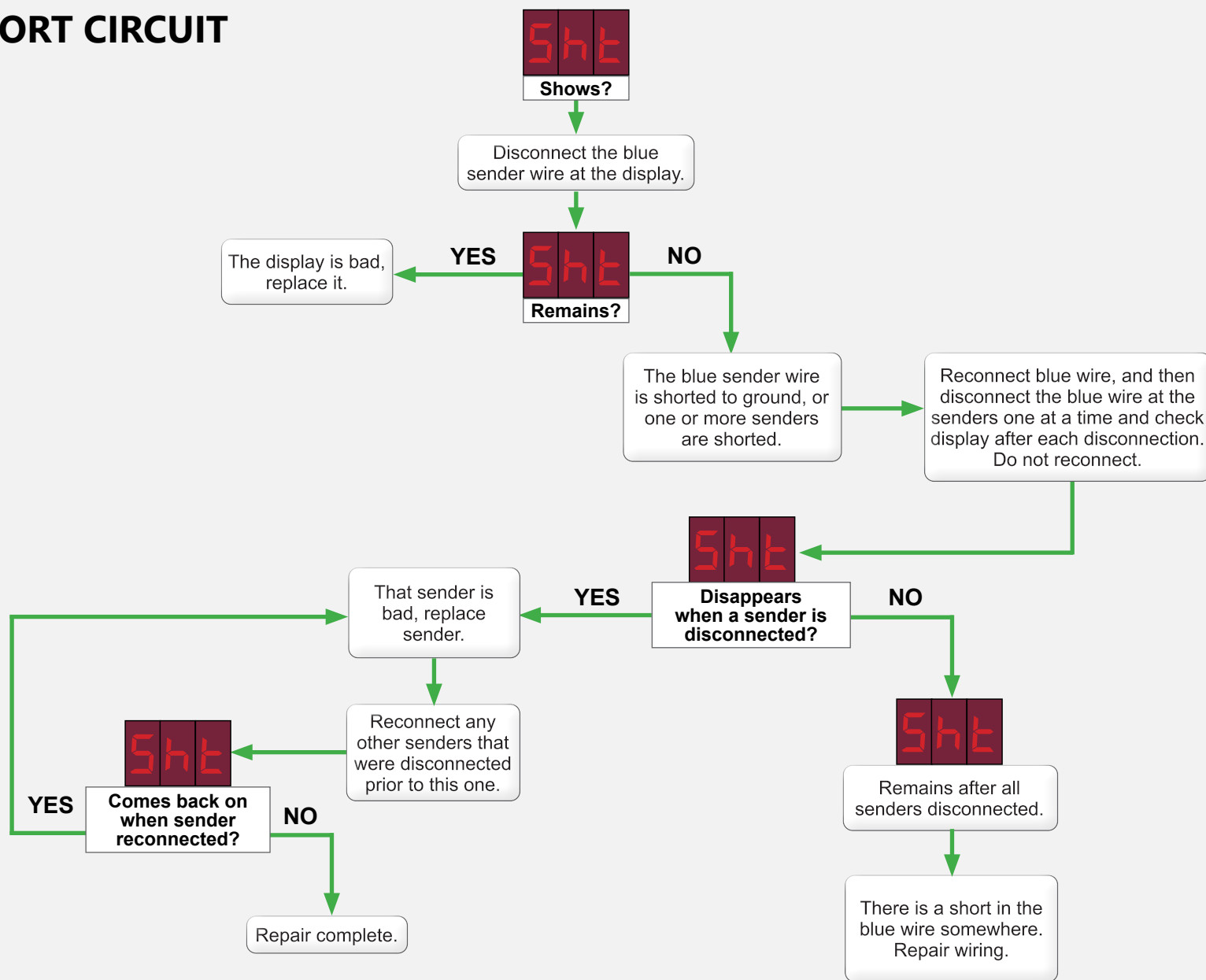

Troubleshooting & Installation Tips

What to do if the system freezes or is unresponsive

If the display is unresponsive, it may be “hung” due to a static discharge or electrical noise. Try rebooting it by shutting off the 12V power to it for a few seconds, then turning it back on.

What to do if operation becomes erratic or stops completely

Make sure all wiring connections are solid. Do not use spade connectors to join wiring as they will degrade over time. Use insulated crimp-on butt connectors or solder and insulate the wire connections.

What to do in dual console systems if the two displays do not read the same

For dual display console applications, if the consoles disagree the most likely reason is a bad console ground. Both console grounds, and the sender grounds, must be connected together with ground wiring. Do not depend on metal chassis components. See item 2 in the following section for further details.

What to do if readings jump or are inaccurate

1. We have had a few instances where 120VAC interference has caused the readings to stall and create a gap; readings would skip from 50% to 70% and then begin to function again. The cause was wiring between consoles and senders being tied too close to entrance boxes for shore power or bundled with other high AC voltage lines or junction boxes.
2. Always ground the senders and the console to the same ground circuit. This is very important; RV's can have several ground circuits with resistance between them. We have had instances where two consoles are installed with a different ground for the service bay console and interior console. If you see different levels from each console on the same tank, then the ground circuit is not common. Connect both consoles to the same ground back to the breaker panel ground point.

What to do if the system indicates a residual or non-zero water level even though the tank is drained completely

1. This can be due to a convex tank bottom or a sloped tank bottom. In the case of the convex bottom tank a ring of water may remain after draining. In the case of the sloped bottom (to the drain valve side) a very small amount of water left in the tank will result in a non-zero level indication. In both of these cases, temporary installation of the sender using duct tape or masking tape will allow the installer to check the tank level before committing to a final sender position. After cutting the sender to length and connecting the wires, be sure to tape down both sides of the sender to eliminate air gaps between the sender and tank surface which can cause low signal strength and unpredictable performance. The ends of the sender must be at least ¼” to ½” away from the tank bottom and top to allow for wall thickness. The exterior bottom & top of the tank are not the same as the interior bottom & top; depending on the tank wall thickness the inside height is ½” to 1” shorter than the outside height. Knowing the wall thickness of your tank will allow you to find the optimal sender position; placing the sender where it can “see” the water will ensure proper level calculation and sender operation.

2. The signal strength should be in the 50% range for best performance. If the signal strength is in the 20% range it is indicative of a high resistance in a connector, a bad ground, or improper bonding of the sender to the tank (a possible air gap on one or both sides of the sender).
3. With the console installed you can check the level on each tank, if you get an indicated level of 10% to 20% and you know this is too high, reposition the sensor board as follows:

▲ NOTE: In the case of a convex tank bottom, usually found on large flat tanks, raising the sender is the best solution to accomplish a zero reading when the tank is empty. This may result in having to shorten the sender by an additional segment.

On sloped tanks, which are used to promote complete draining, one alternative is to measure the end of the tank opposite from the drain valve. It may be necessary to extend the wire harness to be able to measure on the optimal side. On the drain valve side, the best choice is to elevate the sender to avoid reading a puddle at the drain valve.

4. The close proximity of metal to the sender can be misinterpreted as water, since they have similar electrical characteristics. Any metal such as steel, aluminum, copper, or brass can affect the sender reading if it is closer than about 2” from the face of the sender. If there are metal frame pieces, brackets, straps, pipes, ducts, etc. close to the sender you may have to move the sender away from them. Again, trial positioning using tape is necessary until the problem disappears. Flexible pieces of metal can be held away from the sender with rubber wedged between the sender and the metal. If the metal is off to the side of the sender, or just butting to the edge then it is usually not a problem, particularly on the right hand side of the sender.
5. Make sure that metal doors or covers are far enough away from the sender as well, once everything is closed up the positioning may change. The symptoms of exposure to large metal components are usually a non-zero reading when the tank is empty, or the level appearing to jump suddenly as the tank is drained or filled.
6. On fresh tanks there is sometimes a potential to not be able to use all the water in the tank, we suggest you elevate the fresh sender 1” off the tank bottom and position the top of the sender to allow for vent position (if the vent is on the side of the tank). This way you should see ‘0’ before the pump starts to suck air. Some tanks have a sump style draw system, in this case there is no concern with unusable water, just allow for the wall thickness when positioning the sender board (usually ½” to 1” margin from the outer shell). If the sender is positioned above the vent then the maximum reading may be less than 100%.
7. There may be a buildup on the inside walls of black and grey tanks. We get calls occasionally about older coaches that have not been in service for a few years in which the black tank will now indicate a level even though it is empty. The likely cause is that the tank has a significant build-up, probably exceeding ¼” to ½” thick! Redex is not an acceptable chemical to promote clean tank walls; it is far too slow to get the breakdown action started. Use an RV type of liquid chemical, we suggest Tissue Digester, Sensor Cleaner, or the latest we have used called Happy Campers Holding Tank Extreme Cleaner available at www.happycampersworld.com. The next time you take a trip, leave with

a high concentration of the chemical in the tank and approximately 30% full of fresh water. Hopefully you can drive for 2-3 days allowing the tank levels to rise through normal use. We recommend that you exceed the level that you see the system report when the tank is empty. After the sloshing and the soaking hopefully the build-up will be flushed away when the tank is drained and flushed. If you still have symptoms the treatment may required a few more times. The waste did not build up on the tank wall in one day, so it may not dissolve in one treatment! The build-up looks like water to the system since it holds a significant volume of water in the build-up area. It takes much more than a film or piece of tissue to cause the error.

What to do if the system reads a zero water level at all times, or does not reach 100%

1. This may be due to excessive tank wall thickness. We have tested the sender on an actual tank with 3/8" wall thickness to ensure proper operation. If you encounter an excessively thick tank wall the symptom will be a zero reading regardless of the actual tank level. The cross check would be to test the sender on another tank by taping it in place temporarily, if it now works the tank wall thickness is well over 3/8". You can also use a 1 gallon jug or a 5 gallon pail as a test tank to crosscheck operation of the sender.
2. A symptom we have seen is the sender will not indicate 100% when the tank is full. If the sender is positioned too high on the tank, then water cannot reach high enough on the sender for it to read 100%. The top of the sender must be at least 1/4" to 1/2" away from the top of the tank to allow for wall thickness.
3. Another possibility is a tank wall thickness issue that may occur at the corners or edges of the tank. This has not been a common issue, and the only correction you can make is to move the board slightly lower, away from the thick area.

What to do if sender delamination occurs

1. We have had reports of the senders literally falling off the tanks or showing serious delamination. This is likely caused by a lack of tank surface preparation. Surface prep is very simple, wipe the area to be adhered to with products like Pro Bond, alcohol, or acetone. Do not use thinners because they leave residues which attack the adhesive. Ambient temperatures of less than 60°F or 15°C prevent the bonding agents in the adhesive from working properly; use a heat gun to warm the tank surface if necessary. Also be sure the surface is dry, again a heat gun is the best way to dry the bonding area. Finally, the surface of the tank must be smooth. The adhesive works much better on smooth surfaces, if necessary use an orbital sander with fine grit paper (220 grit) to quickly accomplish the desired smoothness.
2. Another possibility is the wiring harness pulling on the sender. Make sure the wiring to the tank sender is well supported so that it does not put a load on the sender. Be sure to support all connecting harnesses; do not let the board support the harness, this will in time cause delamination of the board from the tank. One simple way to do this is to use Gorilla tape across the top of the sender at a 90 degree angle to the sender orientation, with the wiring held in place by the tape. The wires from the sender must be routed straight up or to the right for reliable operation.

How to protect the sender from road spray and debris

3. On installations where the holding tank is exposed to under chassis road spray and flying rocks etc. we recommend the use of an auto body undercoat, which is easily purchased in auto parts stores. This tar based material clings well to the senders and protects from water and debris.
4. One material in particular is 3M Professional Grade Rubberized Undercoating, product code 03584. Another product that works well is a Dominion Sure Seal rubberized undercoating such as Gravel Guard Rocker Guard Coating.
5. After the system is completed and tested apply the undercoat over the complete board using two coats. Do not use lacquer, enamel paint, or plastic paint for auto bumpers as these contain chemicals that will dissolve the conformal coating on the board and cause malfunctions.

How to avoid damaging the display when mounting

1. If mounting the display in a metal panel or wall there is a risk of permanent damage due to a jagged opening or too small of an opening. The metal panel can short-circuit the display rendering it inoperable and requiring the installer to replace it. Ensure that the edges of the cutout are smooth and that no material is bent outward where it can dig into the display. Make sure that the cutout is large enough so that the display can be easily inserted without having to angle it. There is a 1/2" border all around the display to cover the edge of the hole, so if the hole is a bit larger than the minimum requirement it will still be covered by the display.
2. When fastening the display to the panel, make sure that it is centered in the hole and not resting on one edge.
3. Non-conductive mounting spacers are available to help prevent damaging the display. Contact Garnet for further details.

How to avoid damaging the display or pump switch due to excessive current

1. Please be aware that the water pump switch circuit has a limitation on current draw of 7.5 amps, some large pumps can draw over 10 amps. These high drain pumps must use a relay or the display console printed circuit will overheat and damage the display permanently.
2. If the 12V supply line from the electrical panel does not have a 7.5 amp fuse rating, please be sure to install the supplied fuse holder with a 7.5 amp automotive style fuse inline on the +12V red wire.

WARRANTY & SERVICE INFORMATION

For complete warranty information please visit our Support page. If you do have a warranty claim or if the equipment needs to be services please contact the installation dealer.

www.garnetinstruments.com/support/

If you do need to contact Garnet we can be reached as follows:

CANADA

Garnet Instruments
286 Kaska Road
Sherwood Park, AB T8A 4G7
CANADA
email: info@garnetinstruments.com

UNITED STATES

Garnet US Inc.
5360 Old Granbury Road
Granbury, TX 76049
USA
email: infous@garnetinstruments.com

APPENDIX A

Bluetooth Information

The 709-BTP7 utilizes Bluetooth Low Energy (BLE) to broadcast data packets every two seconds. This connectionless advertising allows any nearby gateway or receiver to capture data without manual pairing; the payload specifications below are provided to help you decode this data for custom integrations.

SeeLevel Standardized BLE Broadcast Map

Device Name: G709, Soul G708

Company ID: 0x0CC0

Manufacturer Data

Byte 0	Byte 1	Byte 2	Byte 3	Byte 4	Byte 5	Byte 6
Serial Number			Fresh 1	Grey 1	Black 1	Fresh 2
Byte 7	Byte 8	Byte 9	Byte 10	Byte 11	Byte 12	Byte 13
Grey 2	Black 2	Galley	LPG	BATT	FutureUse	FutureUse

Serial Number:

24bit little endian number

TANKS		
Fresh1	Level 0 to 100%. Any value above 100 is an exception, see exception list.	ShortCircuit = 101,
Grey1		Open = 102,
Black1		BitCounterError = 103,
Fresh2		StackMisconfig = 104,
Grey2		MissingTop = 105,
Black2		MissingBottom = 106,
Galley		NoCalibration = 107,
LPG		BadChecksum = 108,
		OutOfRange = 109,
		Disabled = 110,
		Ini = 111,
		BadID = 112,

Battery: Battery *100